

**publicity**  
**systems Ltd**  
exhibitions · spaceframe · shell scheme

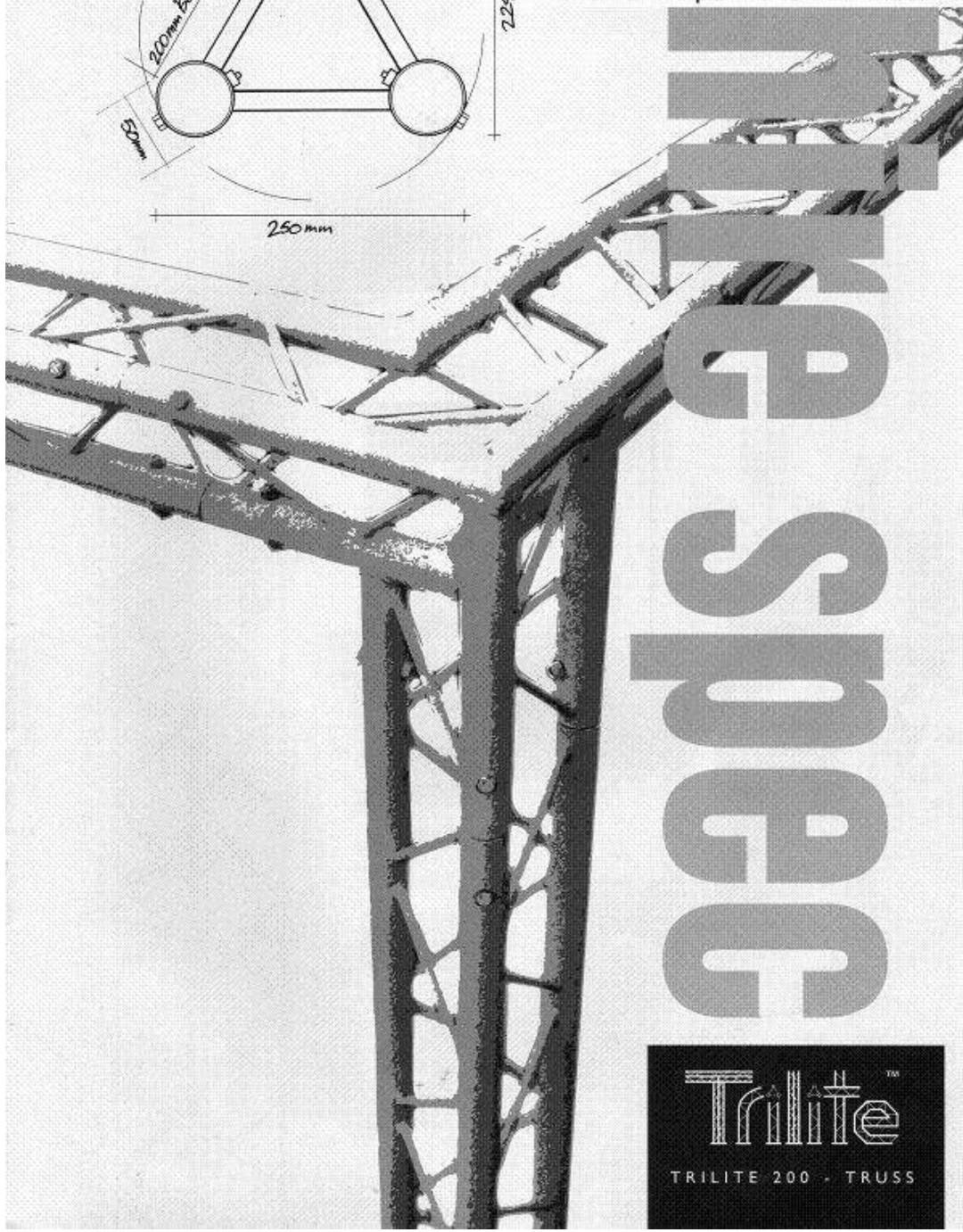

Trilite  
200

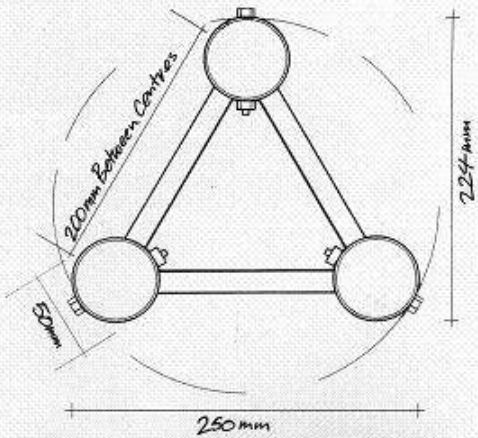

# TRILITE TRUSS



exhibitions · spaceframe · shell scheme

## Straight Sections

TRILITE 200 - TRUSS

200<sub>mm</sub>

400<sub>mm</sub>

600<sub>mm</sub>

800<sub>mm</sub>

1000<sub>mm</sub>

2000<sub>mm</sub>

3000<sub>mm</sub>

4000<sub>mm</sub>

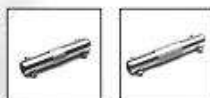

CONNECTION SYSTEM:  
STANDARD, 50mm & 100mm EXPANSION SPIGOTS

# TRILITE TRUSS



TRILITE 200 - TRUSS



APEX UP



APEX DOWN

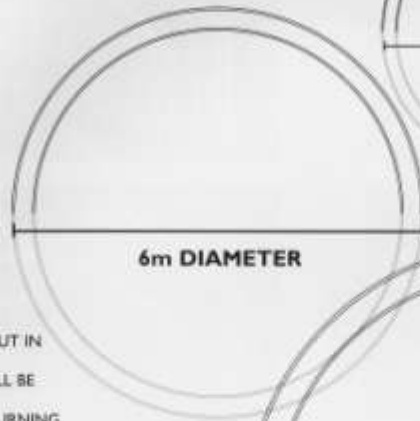

THESE ITEMS WILL BE SUPPLIED COMPLETE BUT IN SECTIONS. HIRERS WILL BE RESPONSIBLE FOR RETURNING ALL SECTIONS IN THE SAME CONDITION AS DELIVERED. MISSING AND DAMAGED ITEMS WILL BE CHARGED.

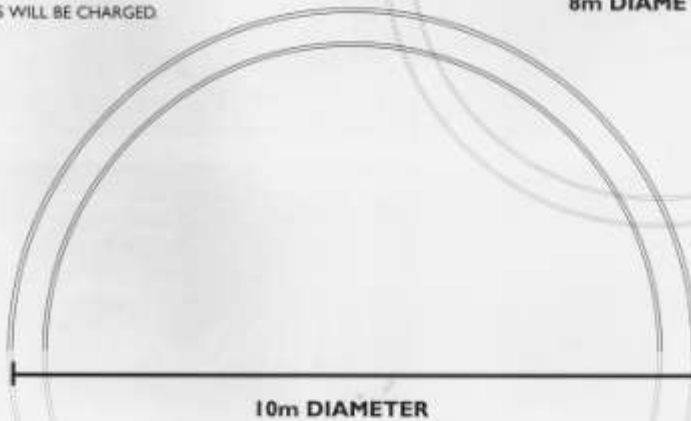
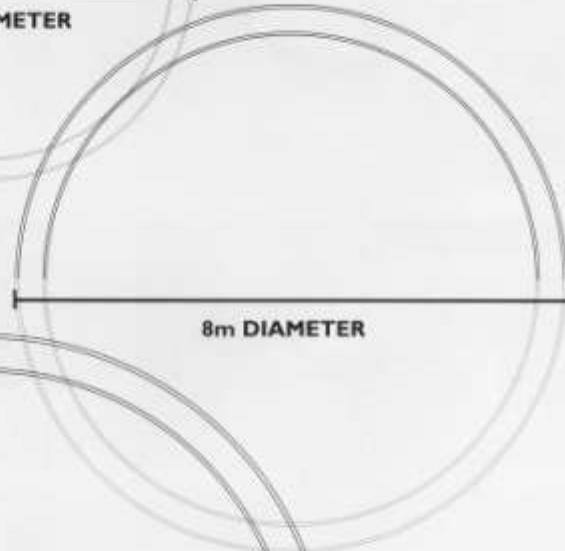

TRILITE

# TRILITE TRUSS



## Two-Way Joints

TRILITE 200 - TRUSS



APEX UP



APEX DOWN



**J2 90A**

INVERTED APEX  
2-WAY

90° Angle



**J2 90AO**

EXTERNAL APEX  
2-WAY

90° Angle

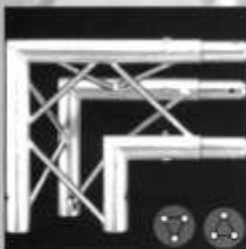

**J2 90**

APEX UP/DOWN  
2-WAY

90° Horizontal Angle

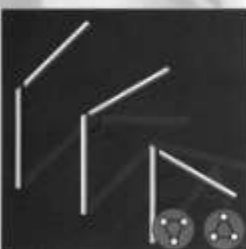

**J2 135**

**J2 120**

**J2 60**

APEX UP/DOWN  
2-WAY

ON REQUEST  
135°, 120°, 60° Angles



**J2 135A**

INVERTED APEX  
2-WAY

135° Angle



**J2 120A**

INVERTED APEX  
2-WAY

120° Angle



**J2 60A**

INVERTED APEX  
2-WAY

60° Angle

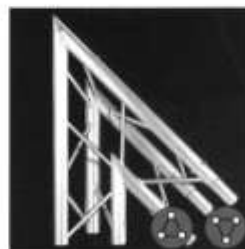

**J2 45**

ON REQUEST

45° Angle

# TRILITE TRUSS



## Three-Way Joints

TRILITE 200 - TRUSS  
TRILITE SERIES 200  
IS USUALLY USED 'APEX DOWN' FOR DESIGNERS  
WISHING TO USE IT 'APEX UP' WE CAN SUPPLY  
'THREE-WAY' CONNECTORS TO DO SO.



ALL APEX DOWN



**J3/3**

VERTICAL WITH  
INVERTED CROSS  
MEMBER ON  
HORIZONTAL

3-WAY



**J3/4**

HORIZONTAL WITH  
IN-LINE VERTICAL

3-WAY



**J3/4DL**

HORIZONTAL WITH  
SIDEWAYS FACING  
VERTICAL

3-WAY



**J3 1L**

INVERTED APEX -  
LEG FACING IN FOR  
MATCHING CORNERS.



**J3 135**

FOR OCTAGONAL  
UNITS

3-WAY

135° Angle



**J3 120**

ON APPLICATION

3-WAY

120° Angle



**J3 60**

FOR TRIANGULAR  
UNITS

60° Angle

3-WAY



**J3 1R**

INVERTED APEX -  
LEG FACING IN FOR  
MATCHING CORNERS.

J3 1L AND J3 1R WOULD USUALLY BE USED AS PAIRS

# ACCESSORIES

## Trilite 200 series

THE ACCESSORIES FEATURED ARE THOSE MOST COMMONLY SPECIFIED FOR USE WITH THE TRILITE 200 SERIES SYSTEM.

IF THE COMPONENT THAT YOU REQUIRE IS NOT FEATURED CONTACT THE DESIGNLINE SERVICE FOR FURTHER ASSISTANCE.

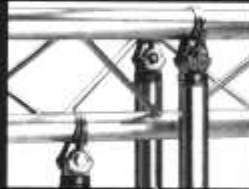

**THREE WAY  
HOOK SET  
V TO H**



**THREE WAY  
HOOK SET  
H TO H**



**2A ORI**



**2A EB**

**OUTRIGGER**

**M10 EYE BOLT**

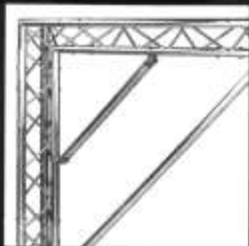

**2A CB1  
2A CB2**



**2A LEC**

**CORNER  
BRACES**

**HALF COUPLER  
WITH LIFTING  
EYE**

**1M & 2M**



**2A ECI B/W**

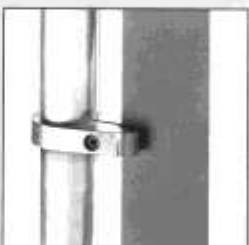

**2A ECI B/W**

**PLASTIC END  
CAPS**

**PANEL CLAMP**

**SETS OF THREE**



**2A BP3  
BASE  
PLATE**



**2A EB3T  
BASE  
PLATE**



**2A SDI  
SADDLE  
CLAMP**



**50mm TUBE  
LAMP HANGING  
CLAMP**

# ACCESSORIES

## Trilite 200 series

THE ACCESSORIES FEATURED ARE THOSE MOST COMMONLY SPECIFIED FOR USE WITH THE TRILITE 200 SERIES SYSTEM.

IF THE COMPONENT THAT YOU REQUIRE IS NOT FEATURED CONTACT THE DESIGNLINE SERVICE FOR FURTHER ASSISTANCE.

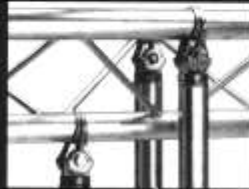

**THREE WAY  
HOOK SET  
V TO H**



**2A ORI**

**OUTRIGGER**

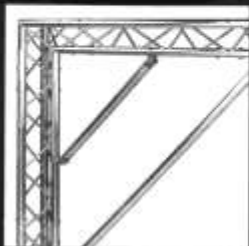

**2A CB1  
2A CB2**

**CORNER  
BRACES**

**1M & 2M**



**2A ECI B/W**

**PLASTIC END  
CAPS**

**SETS OF THREE**



**2A BP3  
BASE  
PLATE**



**2A SDI  
SADDLE  
CLAMP**



**THREE WAY  
HOOK SET  
H TO H**



**2A EB**

**M10 EYE BOLT**



**2A LEC**

**HALF COUPLER  
WITH LIFTING  
EYE**

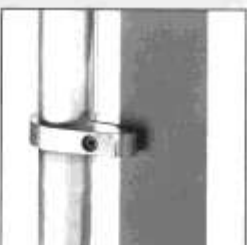

**2A ECI B/W**

**PANEL CLAMP**



**2A EB3T  
BASE  
PLATE**



**50mm TUBE  
LAMP HANGING  
CLAMP**

